



ROUPS48V

v.1.0

ROUPS 54V/5A

RACK mounted buffer power supply.

EN

Edition: 2 from 30.03.2017

Supersedes the edition: 1 from 02.12.2016

Features:

- DC 54V/5A* uninterruptible power supply
- outputs protected by 5A melting fuse
- wide range of mains supply AC: 176÷264V AC
- high efficiency 85%
- built-in power factor correction system (PFC)
- battery charging and maintenance control
- excessive discharging (UVP) protection
- battery output protection against short circuit and reverse connection
- battery charge current: 0,5A (batteries 4x7Ah / 4x17Ah)
- control of voltage presence at the outputs
- acoustic indication of failure
- LED optical indication: AC, DC, TEMP, LoB, ALARM, AUX
- the ALARM technical output of collective failure – relay type, activated by:
 - 230V AC power loss
 - low voltage of the PSU (<46V)
 - activation of the output fuse
 - too high temperature of the PSU (>70°C)
 - the PSU failure
- protections:
 - SCP short-circuit protection
 - OVP overvoltage protection
 - overvoltage protection
 - overload protection OLP
- forced cooling (fan)
- warranty – 2 year from the production date

Sample application of the RACK power supply unit.

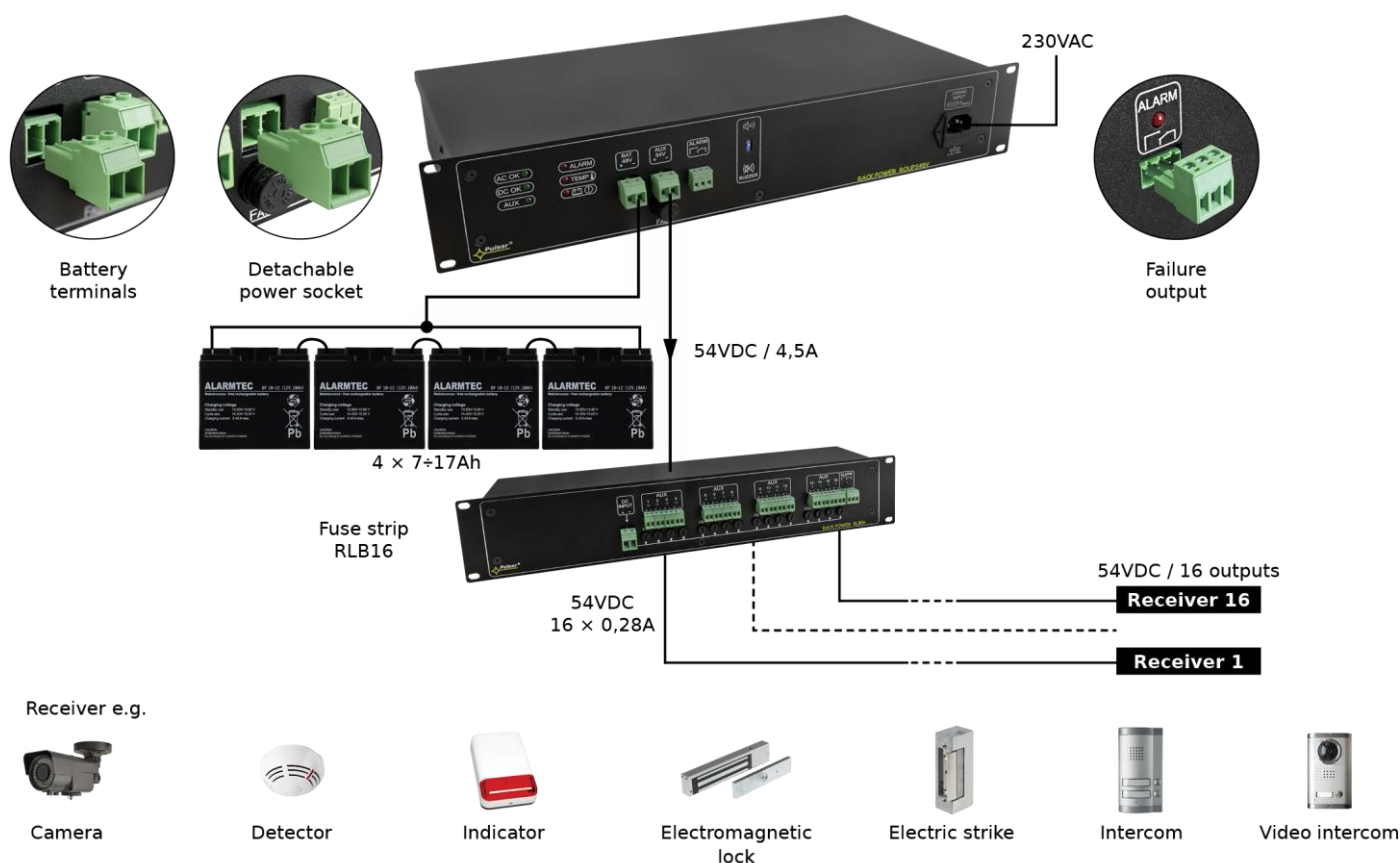

CONTENTS:

1. Technical description.
 - 1.1. General description
 - 1.2. Block diagram
 - 1.3. Description of PSU components and connectors
 - 1.4. Specifications
2. Installation.
 - 2.1. Requirements
 - 2.2. Installation procedure
3. Operating status indication.
 - 3.1. LED indication
 - 3.2. Technical output
 - 3.3. Acoustic indication
4. Operation and use.
 - 4.1. Overload or short circuit of the PSU output
 - 4.2. Battery-assisted operation
 - 4.3. Maintenance

1. Technical description.

1.1. General description.

The **ROUPS48V** buffer power supply unit is designed for uninterrupted power supply of requiring stabilized voltage of **48V DC (+/- 15%)**. The PSU provides voltage of **U=54V DC** current efficiency max. **I=4,5A + 0,5A battery charge**. In case of power decay, a battery back-up is activated immediately. The PSU output protected independently with melting fuse 5A. The power supply is fitted with the **ALARM** output of collective failure. In case of failure, relay contacts are switched automatically, which is accompanied by acoustic and optical indication (the corresponding led goes on). The power supply construction is based on the switch mode PSU with high energy efficiency and is located in an enclosure adapted for mounting in standard **RACK 19"** cabinets.



AUX power supply output can be split into 8 or 16 outputs with the use of RACK fuse modules:

- the RLB8 (RACK 8x2A fuse modules)
- the RLB16 (RACK 16x1 fuse modules)

1.2. Block diagram.

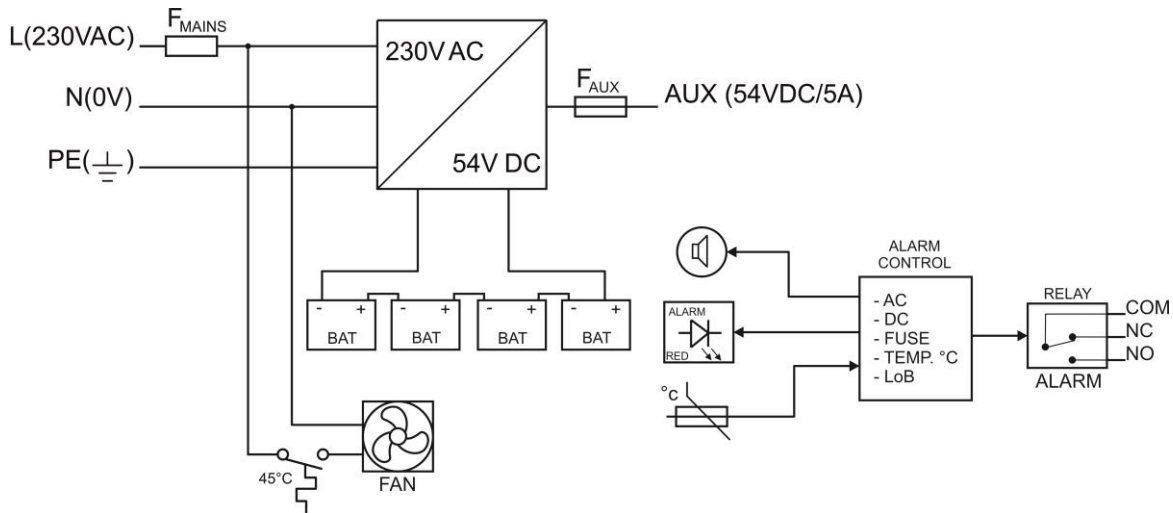



Fig.1. The block diagram of the PSU.

1.3. Description of PSU components and connectors.

Table 1. Elements of the PSU.

Element no. [Fig. 2]	Description
①	AC OK – green LED, indicating the presence of 230V voltage
②	DC OK – green LED, indicating the presence of DC voltage
③	Green LED AUX – voltage indication at the output AUX
④	LED ALARM – red LED failure indication
⑤	TEMP – red LED, indicating too high temperature of the power supply (>70°C)
⑥	LoB – red LED, indicating too low battery voltage (<46V)
⑦	BAT – battery output
⑧	AUX – power output
⑨	ALARM – technical output of collective failure – relay
⑩	BUZZER, micro switch , turning ON / OFF of acoustic indication  switch in the top position, indication ON  switch in the down position, indication OFF
⑪	F_AUX , melting fuse F5A
⑫	230V AC INPUT , power socket 230V AC, power cable 1,5m included
⑬	F_MAINTS , fuse in the supply circuit 230V AC, T 6,3A/250V

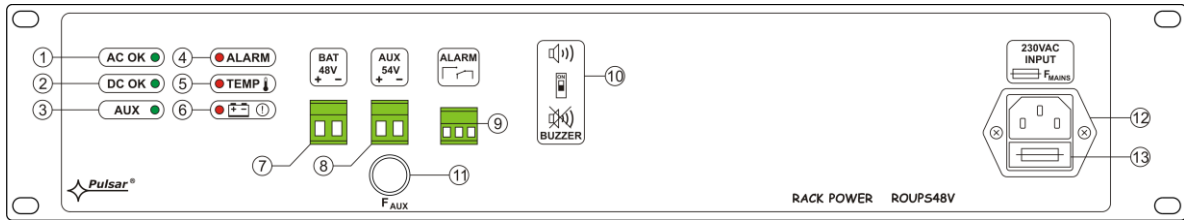

Fig. 2. The front power of the power supply unit.

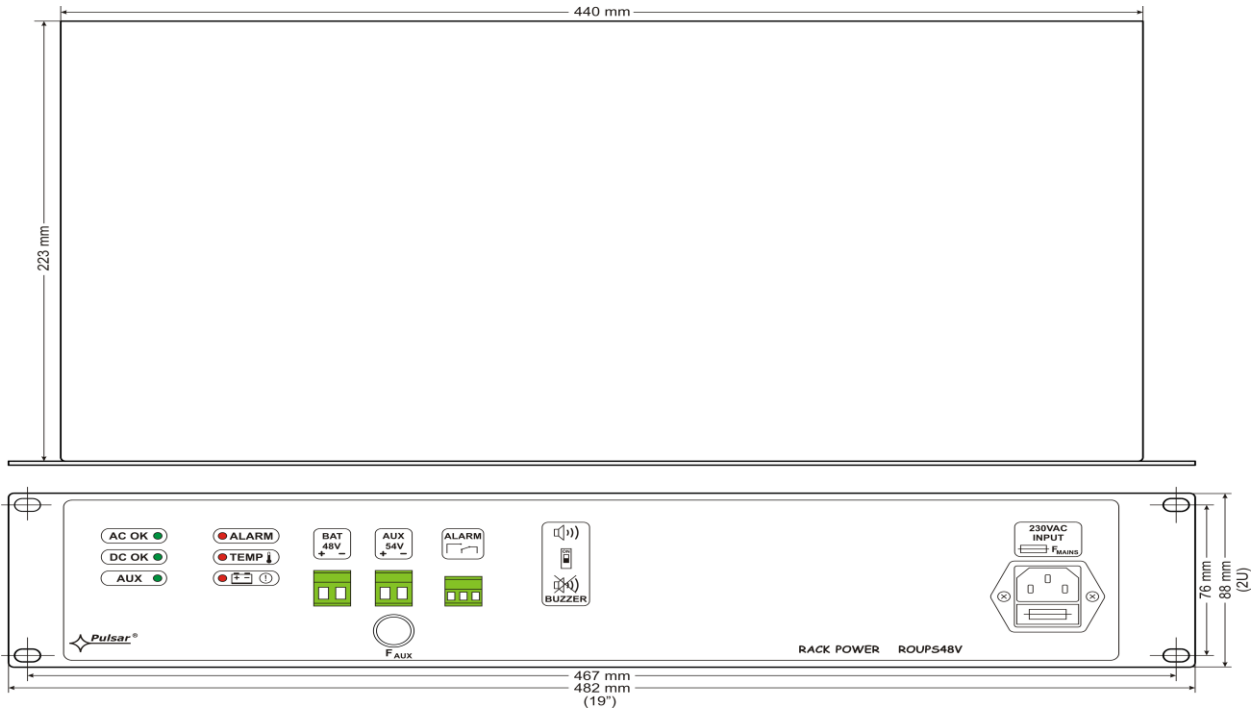

Fig.3. The view of the PSU.

1.4. Specifications.

- electrical parameters (tab.2)
- mechanical parameters (tab.3)
- operation safety (tab.4)
- operating parameters (tab.5)

Electrical parameters (tab. 2).

Mains supply	176÷264V AC
Current up to	1,5A@230V AC max.
Supply power	270W max.
Efficiency	85%
Power factor PF	>0,95@230V AC
Output voltage	44V ÷ 54V DC – buffer operation 38V ÷ 54V DC – battery-assisted operation
Output current	4,5A + 0,5A battery charge
Ripple	150 mV p-p max.
Current consumption by PSU systems	150mA
Battery charge current (batteries 4×7Ah / 4×17Ah, connect batteries in series)	0,5A max. (+/-5%)
Short-circuit protection SCP	F 5A, melting fuse
Overload protection OLP	105% ÷ 150% of the PSU power, automatic return
Overvoltage protection OVP	>62V (activation requires disconnecting the load or supply for about 20s.)
Battery circuit protection SCP and reverse polarity connection	glass fuse
Surge protection	varistors
Excessive discharge protection UVP	U<38V (+/-5%) – disconnect of connection battery
Optical indication of operation:	LED: AC, DC, TEMP, LoB, ALARM, AUX
Acoustic operation indication:	Piezoelectric indicator ~75dB/0,3m
The ALARM technical output of collective failure	Relay type: 1A@ 30VDC/50VAC
The F _{MAINS} fuse in the 230V power supply circuit	T 6,3A
Fuse F _{AUX}	F 5A

Mechanical parameters (tab. 3).

Mounting dimensions	W=19", H=2U, D=262
Dimensions	W=482, W ₁ =442, H=88, D=262, D ₁ =5, D ₂ =32 [+/- 2mm]
Fixation	four-point butt mounting to RACK profiles – the set include 4 M6 screws + cage nuts
Net/gross weight	5,7kg / 6,2kg
Enclosure	Steel plate RAL 9005, black
Connectors	230V AC input: the IEC C14 socket with a fuse, power cable 1,5m (included) Technical output: ALARM: $\Phi 0,5-2,1$ (AWG 24-12) 0,2-1,5mm ² Outputs AUX, BAT: $\Phi 0,5-3,2$ (AWG 24-8) 0,5-4mm ²
Notes	Forced cooling (fan).

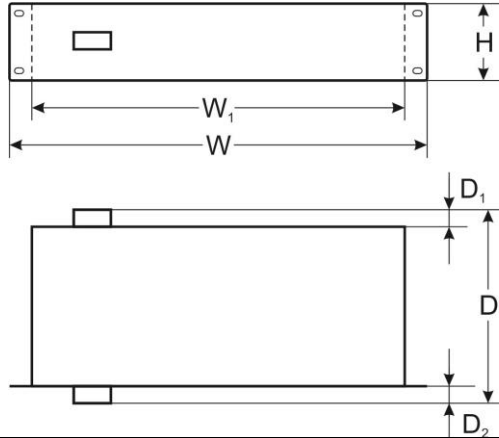

Operation safety (tab.4).

Protection class PN-EN 60950-1:2007	I (first)
Protection grade PN-EN 60529: 2002 (U)	IP20
Electrical strength of insulation: - between input and output circuits of the PSU (I/P-O/P) - between input circuit and PE protection circuit (I/P-FG) - between output circuit and PE protection circuit (O/P-FG)	3000 V/AC min. 1500 V/AC min. 500 V/AC min.
Insulation resistance: - between input circuit and output or protection circuit	100 M Ω , 500V/DC

Operating parameters (tab.5).

Environmental class	II
Operating temperature	-10°C...+45°C
Storage temperature	-20°C...+60°C
Relative humidity	20%...90%, without condensation
Vibrations during operation	unacceptable
Impulse waves during operation	unacceptable
Direct insulation	unacceptable
Vibrations and impulse waves during transport	According to PN-83/T-42106

2. Installation.

2.1. Requirements.

The PSU RACK shall be mounted by a qualified installer with appropriate permissions and qualifications for 230V/AC installations and low-voltage installations (required and necessary for a given country). The device shall be mounted in confined spaces, according to the environment class II, with normal air humidity (RH=90% max. without condensation) and the temperature from -10°C do +45°C.



During normal operation the total current consumption of the cameras cannot exceed I=4,5A. Maximum battery charging current is: 0,5A.

Total device current + battery: 5A max.

As the PSU is designed for a continuous operation and is not equipped with a power-switch, therefore an appropriate overload protection shall be guaranteed in the power supply circuit. Moreover, the user shall be informed about the method of unplugging (usually through assigning an appropriate fuse in the fuse-box). The electrical system shall follow valid standards and regulations.

2.2. Installation procedure.

1. Before installation, cut off the voltage in the 230V power-supply circuit.
2. Mount the power supply in a RACK 19" cabinet as shown below:



- Mount M6 cage nuts



- Secure the enclosure with 4xM4 screws

3. Connect the receivers' cables to the terminals AUX.
4. If needed, the following technical connections can be made:
 - ALARM – technical output of collective failure
5. Connect the battery in series to the +BAT- terminals:
 - battery output (+): terminal BAT+
 - battery output (-): terminal BAT-

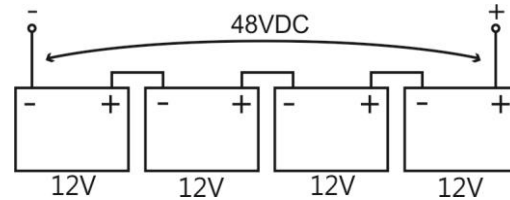

6. Connect the ~230V AC power cord with the IEC C13 plug (included) to the 230V AC power supply and turn on the power (~230V).
7. Check the PSU operation indicator.

3. Operating status indication.

3.1. LED indication.

The PSU has 6 LED lights at the front panel:



GREEN LED:

- on – the PSU is supplied with 230V AC
- off – no 230V AC supply



GREEN LED:

- on – DC voltage at the output of the switch mode PSU
- off – no DC voltage at the output of the switch mode PSU



GREEN LED:

- on – DC voltage in the AUX output
- off – no DC voltage in the AUX output



RED LED:

- on – failure
- off – no failure



RED LED:

- ON – too high temperature of the switch mode power supply (>70°C)
- OFF – standard temperature of the switch mode power supply



RED LED:

- on – battery voltage <46V
- off – battery voltage >46V

3.2. Technical output.

The power supply is fitted with the **ALARM** output of collective failure (relay type). A collective failure can be triggered by the following events:

- 230V AC mains power failure
- Activation of the glass fuse F_{AUX}
- Failure of the switch mode power supply
- Too high temperature of the switch mode power supply (>70°C)
- Low battery voltage (<46V)

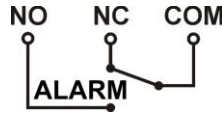

Fig. 4. Electrical diagram of the ALARM collective output of failure.



CAUTION! In Fig.4 the set of contacts shows a potential-free status of the relay, which corresponds to power supply failure.

3.3. Acoustic indication.

A collective failure is indicated by the piezoelectric indicator, 1 beep every second. The acoustic indication can be turned off by changing the ON / OFF position of the switch »)).



switch in the up position, indication ON

switch in the down position, indication OFF

4. Operation and use.

4.1. Overload or short circuit of the PSU output.

The power supply outputs are protected against short-circuit with glass fuses. If a fuse-assisted protection has been chosen, replace the fuse (of the same parameters) in case of a failure.

4.2. Battery-assisted operation

In case of a main power outage, the device is immediately switched into a battery-assisted operation.



The PSU is equipped with the discharged battery disconnection system. During the battery-assisted operation, reducing voltage below 38V at the battery terminals will cause battery disconnection.

4.3. Maintenance.

Any and all maintenance operations may be performed following the disconnection of the PSU from the power supply network. The PSU does not require performing any specific maintenance measures. In case of fuse replacement, use a replacement of the same parameters.

**WEEE LABEL**

Waste electrical and electronic equipment must not be disposed of with normal household waste. According to the European Union WEEE Directive, waste electrical and electronic equipment should be disposed of separately from normal household waste.

CAUTION! The power supply unit is adapted for a sealed lead-acid battery (SLA). After the operation period it must not be disposed of but recycled according to the applicable law.

Pulsar

Siedlec 150, 32-744 Łapczyca, Polska
Tel. (+48) 14-610-19-40, Fax. (+48) 14-610-19-50
e-mail: biuro@pulsar.pl, sales@pulsar.pl
http:// www.pulsar.pl, www.zasilacze.pl