



USER MANUAL

EN

Edition: 2 from 04.04.2019

Supersedes the edition: 1 from 14.02.2019

Power supplies EN54C series

v.1.0

**Power supplies for fire alarm systems and
smoke and heat control systems.**

RED POWER plus



GENERAL SAFETY RULES



Before installation, read the instruction manual to avoid errors that can damage the device and give you an electric shock.

- Before installation, cut off the voltage in the 230 V power-supply circuit.
- To switch power off, use an external switch, in which the distance between the contacts of all poles in the disconnection state is not less than 3mm.
- The shock protection circuit shall be done with a particular care: the yellow and green wire coat of the power cable should be connected to the terminal marked with the grounding symbol on the PSU enclosure. Operation of the PSU without the properly made and fully operational shock protection circuit is UNACCEPTABLE! It can cause damage to the equipment or an electric shock.
- The device should be transported without batteries. This has a direct impact on the safety of the user and the device.
- Installing and connecting the power supply must be carried out without batteries.
- When connecting batteries to the power supply, pay particular attention to the correct polarity. If necessary, it is possible to permanently disconnect the battery from the power supply systems by removing the F_{BAT} fuse.
- The power supply is adapted to be connected to a power distribution network with an effectively earthed neutral conductor.
- Ensure a free, convection air flow around the enclosure. Do not cover the ventilation openings.

TABLE OF CONTENTS

1. PSU FEATURES.....	4
2. FUNCTIONAL REQUIREMENTS OF THE PSU.	5
3. TECHNICAL DESCRIPTION.....	6
3.1. GENERAL DESCRIPTION.	6
3.2. BLOCK DIAGRAM.	7
3.3. DESCRIPTION OF COMPONENTS AND POWER SUPPLY TERMINALS.	7
4. INSTALLATION.....	10
4.1. REQUIREMENTS.	10
4.2. INSTALLATION PROCEDURE.	11
4.3. PROCEDURE FOR CHECKING THE POWER SUPPLY AT THE PLACE OF INSTALLATION.	12
5. FUNCTIONS.....	13
5.1. CONTROL PANEL.	13
5.2. TECHNICAL OUTPUTS.	13
5.3. INPUT OF COLLECTIVE FAILURE: EXTl.	14
5.4. INDICATION OF THE ENCLOSURE OPENING - TAMPER.	16
5.5. PSU OVERLOAD.	16
5.6. SHORT-CIRCUIT OF THE PSU OUTPUT.	16
5.7. ADDITIONAL MODULES.	16
5.7.1. Extending the number of PSU outputs - EN54C-LB4 and EN54C-LB8 fuse modules.	16
5.7.2. Cooperation with electric actuators - EN54C-LS4 and EN54C-LS8 sequential modules.	17
6. RESERVE POWER SUPPLY CIRCUIT.....	18
6.1. BATTERY DETECTION.	18
6.2. PROTECTION AGAINST SHORT-CIRCUIT OF THE BATTERY TERMINALS.	18
6.3. PROTECTION AGAINST REVERSE BATTERY CONNECTION.	18
6.4. DEEP DISCHARGE BATTERY PROTECTION UVP.	18
6.5. BATTERY TEST.	18
6.6. MEASUREMENT OF THE RESISTANCE OF THE BATTERY CIRCUIT.	18
6.7. BATTERY TEMPERATURE MEASUREMENT.	18
6.8. STANDBY TIME.	19
7. TECHNICAL PARAMETERS.	20
Table 4. Electrical parameters.	20
Tabela 5. Mechanical parameters.	22
Table 6. Safety of use.	22
Table 7. Operation parameters.	23
Table 8. Recommended types and sections of installation cables.	23
8. TECHNICAL INSPECTIONS AND MAINTENANCE.....	24

1. PSU features.

- In accordance with standards: EN 54-4, EN12101-10
- 27,6 V DC uninterruptible power supply
- available versions with **2 A/3 A/5 A/10 A** current efficiencies
- available versions with space for **7 Ah – 65 Ah** batteries
- independently protected outputs AUX1 and AUX2
- high efficiency (up to 89%)
- low level of voltage ripple
- microprocessor-based automation system
- measurement of the resistance of the battery circuit
- automatic temperature-compensated charging
- automatic battery test
- two-stage battery charging process
- accelerated battery charging
- monitoring of the continuity of the battery circuit
- monitoring of the battery voltage
- monitoring of charging and maintenance of the batteries
- cooperation with EN54C-LB4 and EN54C-LB8 fuse modules (optional equipment)
- cooperation with EN54C-LS4 and EN54C-LS8 sequential modules (optional equipment)
- optical indication – LED panel
- deep discharge battery protection (UVP)
- battery overcharge protection
- the LoB low battery voltage indication
- battery output protection against short-circuit and reverse connection
- output voltage control
- fuse monitoring of AUX1 and AUX2 outputs
- relay output of collective failure ALARM
- EPS relay output indicating 230 V power loss
- the EXTi input of external failure
- protections:
 - SCP short-circuit protection
 - OLP overload protection
 - OVP overvoltage protection
 - Surge protection
 - Antisabotage protection – Tamper
- closing the enclosure - lock
- convection cooling (forced only in the EN54C-10Axx)
- warranty - 3 years from the production date

2. Functional requirements of the PSU.

The buffer power supplies for fire alarm systems has been designed in accordance with the following standards:

- EN 54-4:2001+A1:2004+A2:2007 Fire detection and fire alarm systems.
- EN 12101-10:2007+AC:2007 Smoke and heat control systems.

Functional requirements	Requirements according to standards	Power supplies EN54C series
Two independent power sources	YES	YES
External Power Supply failure indication	YES	YES
Two independent power supply outputs protected against short-circuit	YES	YES
Temperature-compensated battery charging	YES	YES
Measurement of the resistance of the battery circuit	YES	YES
Low battery indication	YES	YES
Recharging the battery to 80% of the rated capacity within 24 hours	YES	YES
Deep discharge battery protection	YES	YES
Short-circuit protection of battery terminals	YES	YES
Battery fuse failure indication	YES	YES
Charging circuit failure indication	YES	YES
Short-circuit protection	YES	YES
Overload protection	YES	YES
Output of collective failure ALARM	YES	YES
EPS technical output	YES	YES
Low output voltage indication	-	YES
High output voltage indication	-	YES
Indication of power supply failure	-	YES
Overvoltage protection	-	YES
Input of an external failure indication EXTi	-	YES
Tamper indicating enclosure opening	-	YES

3. Technical description.

3.1. General description.

The buffer power supplies has been designed for an uninterrupted supply of fire alarm systems, smoke and heat control systems, fire protection equipment and fire automatics requiring stabilized voltage of 24 V DC ($\pm 15\%$). The power supplies are fitted with two independently protected AUX1 and AUX2 outputs, which provide a voltage of **27,6 V DC** and the total current efficiency depending on the version:

The power supply model	Battery	Continuous operation I _{max a}	Instantaneous operation I _{max b}
EN54C-2A7	7 Ah	1,6 A	2 A
EN54C-2A17	17 Ah	1,2 A	
EN54C-3A7	7 Ah	2,6 A	3 A
EN54C-3A17	17 Ah	2,2 A	
EN54C-3A28	28 Ah	1,8 A	
EN54C-5A7	7 Ah	4,6 A	5 A
EN54C-5A17	17 Ah	4,2 A	
EN54C-5A28	28 Ah	3,8 A	
EN54C-5A40	40 Ah	3,2 A	
EN54C-5A65	65 Ah	2,4 A	
EN54C-10A17	17 Ah	9,2 A	10 A
EN54C-10A28	28 Ah	8,8 A	
EN54C-10A40	40 Ah	8,2 A	
EN54C-10A65	65 Ah	7,4 A	

In case of power loss, the PSU switches to battery power, providing uninterruptible power supply. The power supply unit is housed in a metal enclosure (color red RAL 3001) with space for battery.

Power supply units works with maintenance-free lead acid batteries made with AGM technology or gel technology.

3.2. Block diagram.

The power supplies has been manufactured based on a high-efficiency system of AC/DC converter. Applied microprocessor circuit is responsible for the full diagnostics of the PSU parameters and batteries. The figure below shows a flowchart of the power supply, along with selected functional blocks which are essential for the proper functioning of the unit.

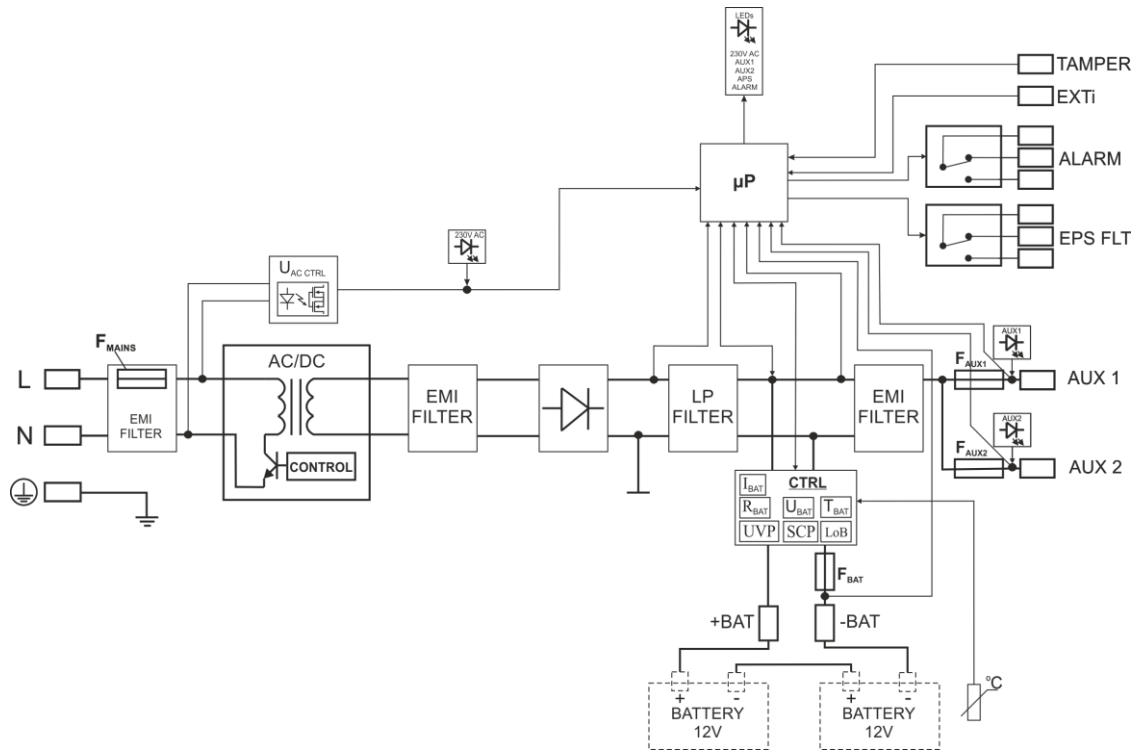

Fig. 1. PSU block diagram.

3.3. Description of components and power supply terminals.

Table 1. Elements of the PSU (Fig. 2).

Component No.	Description
1	L-N-PE 230 V power connector with protective terminal
2	<p>Terminals:</p> <p>TEMP – input of the battery temperature sensor</p> <p>TAMPER – input of the microswitch tamper Closed input = no indication Open input = alarm</p> <p>ALARM – technical output of collective failure of the PSU - relay type</p> <p>EPS – technical output of AC power failure indication open = AC power failure closed = AC power - O.K.</p> <p>EXTi – external failure input Closed input = no indication Open input = alarm</p> <p>+BAT- – terminals for connecting the battery</p> <p>+AUX1- – AUX1 power output (- AUX=GND)</p> <p>+AUX2- – AUX2 power output (- AUX=GND)</p> <p>CAUTION! In Fig.2 the set of contacts shows a potential-free status of the relay, which corresponds to power supply failure.</p>
3	<p>Fuses:</p> <p>F_{BAT} – fuse in the battery circuit,</p> <p>F_{AUX1} – fuse in the AUX1 output circuit,</p> <p>F_{AUX2} – fuse in the AUX2 output circuit,</p> <p>The fuse values are given in table 4 - "Electrical parameters".</p>

④	LEDs – optical indication: 230 V – voltage in the 230 V circuit APS – battery failure ALARM – collective failure AUX1 – AUX1 output voltage (at the AUX1 connector) AUX2 – AUX2 output voltage (at the AUX2 connector)
⑤	PANEL LED – connector to the external LED indicators
⑥	Battery temperature sensor
⑦	Battery connectors; positive: +BAT = red, negative: - BAT = black

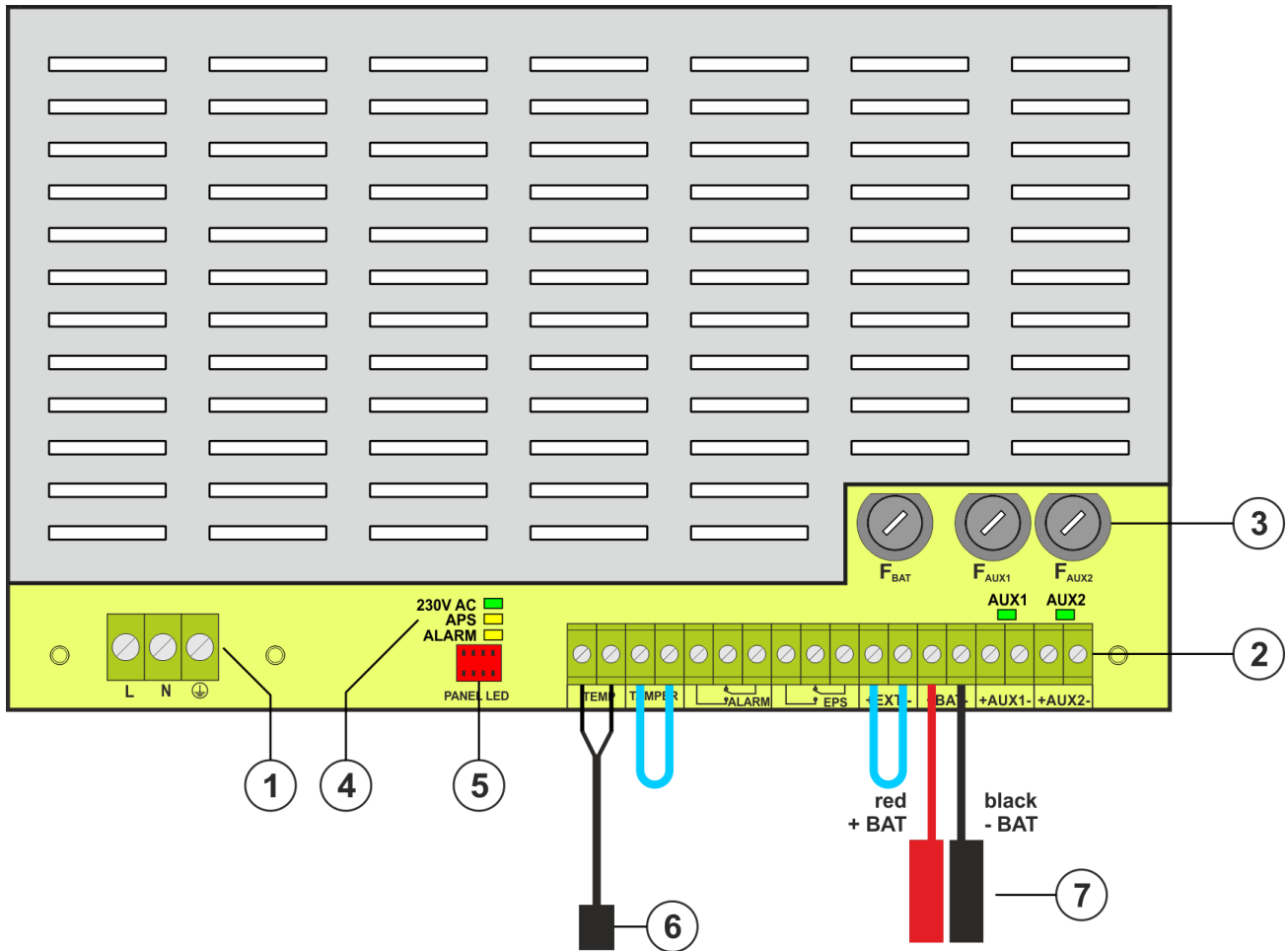

Fig. 2. The view of the power supply module based on the EN54C-2A7.

Table 2. Elements of the PSU (Fig. 3).

Component No.	Description
①	PSU (tab. 1, Fig. 2)
②	Battery temperature sensor
③	Battery connectors; positive: +BAT = red, negative: - BAT = black
④	Place to install the EN54C-LB4 or EN54C-LB8 fuse module
⑤	TAMPER; microswitch (contacts) of antisabotage protection (NC)
⑥	Fitting battery
⑦	Embossing for cable gland
⑧	Embossings for concealed wires
⑨	Lock

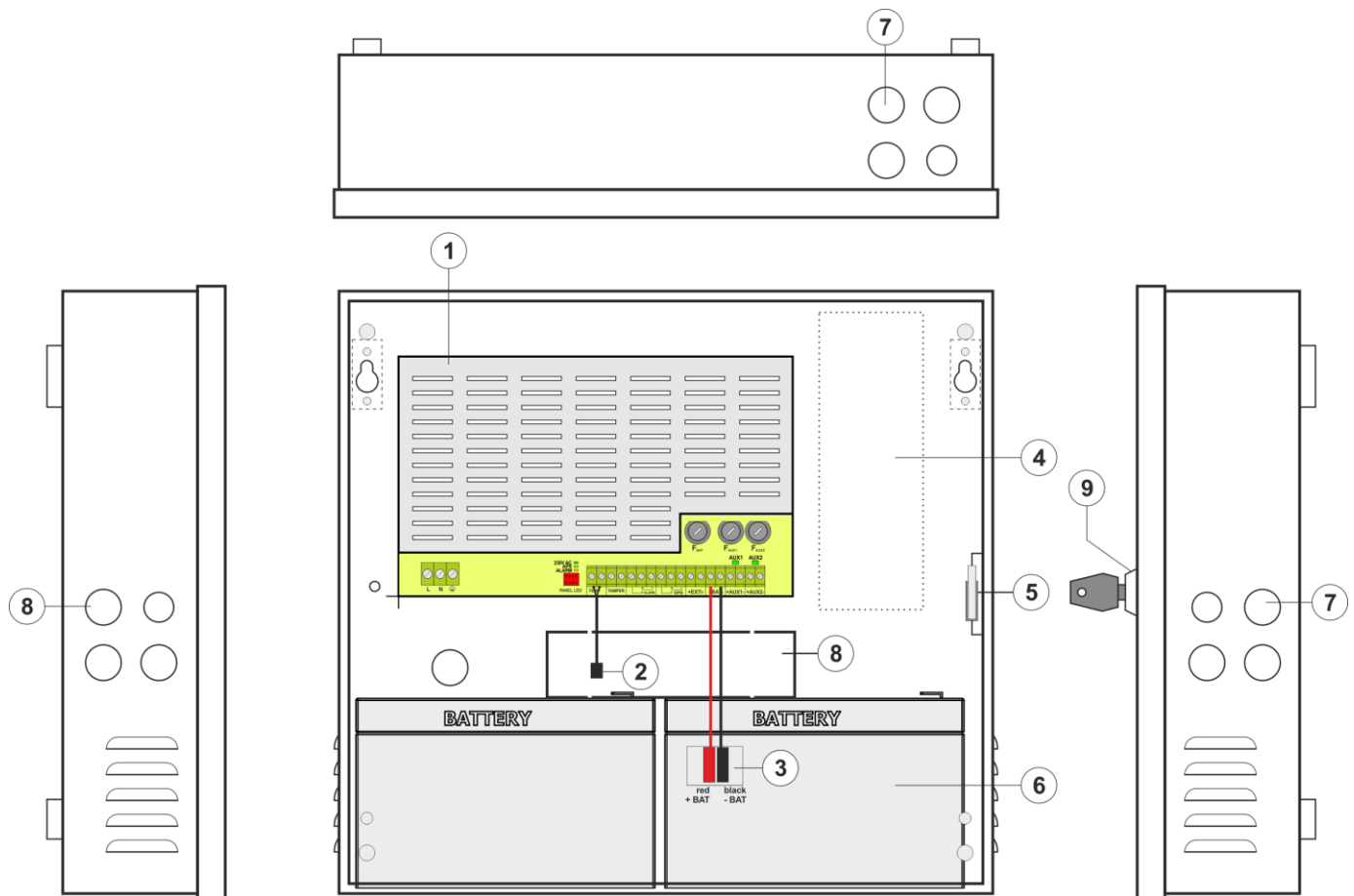

Fig. 3. The view of the power supply based on the EN54C-2A7.

4. Installation.

4.1. Requirements.

The PSU is to be mounted by a qualified installer, holding relevant permits and licenses (applicable and required for a given country) for ~230 V in and low-voltage installations.

As the power supply is designed for a continuous operation and is not equipped with a power-switch, therefore, an appropriate overload protection in the power supply circuit should be provided. Moreover, the user should be informed how to disconnect the power supply unit from the mains supply (usually by assigning an appropriate fuse in the fuse box). One switch should only protect one power supply. The electrical system shall follow valid standards and regulations. The power supply should operate in a vertical position in order to provide free and convectional air flow through ventilating holes of the casing.

As the PSU cyclically runs a periodic battery test, during which the resistance in the battery circuit is measured, pay attention to the proper connection of cables to the terminals. Installation cables should be firmly connected to the battery side terminals and to the power supply connector. If necessary, it is possible to permanently disconnect the battery from the power supply systems by removing the F_{BAT} fuse.

The side walls of the housing include the embossings, which should be used to carry out installation cables. Use a blunt instrument to make an opening for cable gland from the outside of the housing. Then, carefully mount the cable gland, protecting the PSU from water penetration, in the opening.

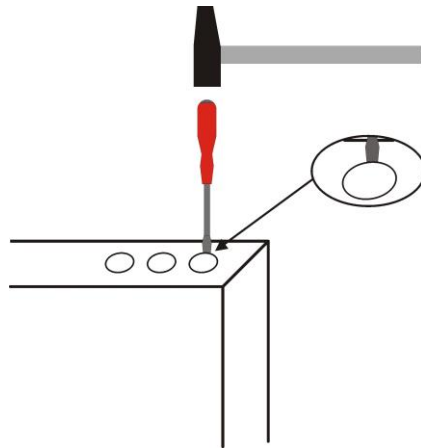

Fig. 4. The method of forming an opening for cable gland.

The PSU is fitted with PG9 and PG11 cable glands. Gland size should be chosen depending on the cross-section of the cable. Single cable gland can be used for only one wire.

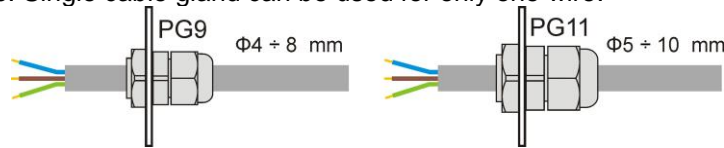

Fig. 5. Recommended types and sections of installation cables PG9 and PG11 for cable glands.

4.2. Installation procedure.



CAUTION!

Before installation, cut off the voltage in the 230 V power-supply circuit.
To switch power off, use an external switch, in which the distance between the contacts of all poles in the disconnection state is not less than 3mm.

It is required to install an installation switch with a nominal current of 6 A in the power supply circuits outside the power supply unit.

1. Mount the PSU in a selected location with use of special metal expansion bolts. Do not use PVC dowels.
2. Connect the power cables ~230 V to the L-N terminals of the PSU. The cable length inside the housing should not exceed 10 cm. Connect the ground wire to the terminal marked with grounding symbol in enclosure. Use a three-core cable (with a yellow and green protection wire) to make the connection.







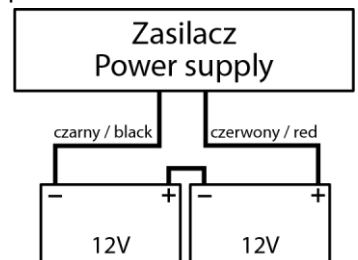

The shock protection circuit shall be done with a particular care: the yellow and green wire coat of the power cable should be connected to the terminal marked with the grounding symbol on the PSU enclosure. Operation of the PSU without the properly made and fully operational shock protection circuit is UNACCEPTABLE! It can cause damage to the equipment or an electric shock.

3. Connect the receivers' cables to the AUX1 and AUX2 output terminals on the PSU board.
4. If needed, connect the cables from the devices to the technical inputs and outputs:
 - ALARM; technical output of collective failure of the PSU
 - EPS; technical output of AC power loss indication
 - EXTi; input of collective failure
5. Install the batteries in a designated area of the enclosure (see Fig. 3). Connect the batteries with the PSU paying special attention to the correct polarity. Batteries must be connected in series using the special cable (included). Attach the temperature sensor to any of the batteries with mounting tape (included). Place the temperature sensor between the batteries.
6. Switch on the ~230 V supply. The corresponding LEDs on the power supply PCB should be ON: 230 V green and AUX1, AUX2.
7. Check the current consumption of the receivers, taking into account the battery charging current, so as not to exceed the total current efficiency of the PSU (see section 3.1).
8. Once the tests are completed, close the enclosure.



4.3. Procedure for checking the power supply at the place of installation.

1. Check the indication displayed on the front panel of the power supply unit:
 - a) The 230 V LED  should remain lit to indicate the presence of the mains supply voltage.
 - b) The 230 V LED  should remain lit to indicate the presence of the supply voltage.
2. Check the output voltage after 230 V power failure.
 - a) Simulate the lack of 230 V mains voltage by disconnecting the main circuit breaker.
 - b) The 230 V LED  should go out.
 - c) The AUX LED  should remain lit to indicate the presence of the output voltage.
 - d) The LED ALARM LED  will start blinking.
 - e) The EPS and ALARM technical outputs will change status into opposite after 10s.
 - f) Turn on the 230 V mains voltage again. Indication should return to the initial status from point 1 after a few seconds.
3. Check whether the lack of continuity in the battery circuit is properly indicated.
 - a) During normal PSU operation (230 V mains voltage on), disconnect the battery circuit by disconnecting the F_{BAT} fuse.
 - b) Within 5 minutes the PSU will start signaling a failure in the battery circuit.
 - c) The ALARM LED  will start blinking.
 - d) The ALARM technical output will change status into opposite.
 - e) Turn on the F_{BAT} fuse in the battery circuit again.
 - f) The power supply should return to normal operation, indicating the initial status, within 5 minutes after the battery test is completed.

5. Functions

5.1. Control Panel.

The PSU is equipped with a LED panel allowing checking the current status of the power supply.

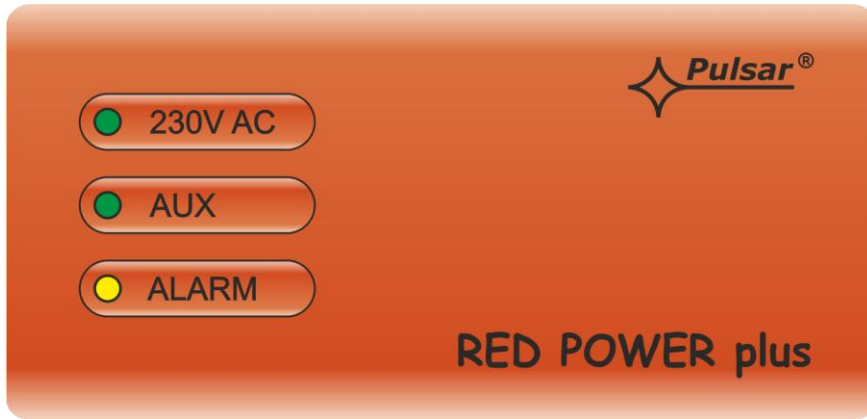





Fig. 6. Control panel.

Table 3. The description of the buttons and LEDs of the LCD panel.

 230V AC	- green LED indicating 230 V voltage
 AUX	- green LED AUX indicating power at the AUX1 and AUX2 output of the PSU
 ALARM	- yellow LED ALARM indicating collective failure

5.2. Technical outputs.

The power supply is fitted with relay indication outputs changing state upon the occurrence of a specific event.

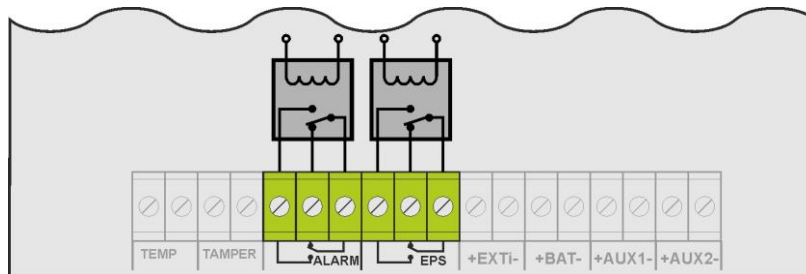

Fig. 7. Electrical diagram of relay outputs.

- **EPS - output indicating 230 V power loss.**

The output indicates 230 V power loss. Under normal status – with the 230 V supply on, the output is closed. In case of power failure, the PSU will switch the output into the open position after a time 10s.



Fig. 8. EPS technical output.



CAUTION! In Figure the set of contacts shows a potential-free status of the relay, which corresponds to power supply failure.

• **ALARM - technical output of collective failure indication.**

Output indicating collective failure. In the case of 230 V power failure, battery circuit failure, PSU failure, or EXTi input activation, the collective failure signal ALARM will be generated.

Failure can be triggered by the following events:

- AC power loss
- faulty batteries
- undercharged batteries
- disconnected batteries
- high resistance of the battery circuit
- no continuity in the battery circuit
- $U_{AUX1, AUX2}$ output voltage below 26 V
- $U_{AUX1, AUX2}$ output voltage over 29,2 V
- battery charging circuit failure
- blown F_{AUX1} or F_{AUX2} fuse
- PSU overload
- to high battery temperature ($>65^{\circ}C$)
- temperature sensor failure, $t < -20^{\circ}C$ or $t > 80^{\circ}C$
- enclosure opening - TAMPER
- internal damage of the PSU



Fig. 9. Technical output ALARM.



CAUTION! In Fig.2 the set of contacts shows a potential-free status of the relay, which corresponds to power supply failure.

5.3. Input of collective failure: EXTi.

The EXT IN (external input) technical input indicating collective failure is intended for additional, external devices that generate the failure signal. Disconnection of the EXTi terminals will cause a failure of the PSU and generate a failure signal at the ALARM output.

The EXTi technical input is not galvanically isolated from the power supply. The "minus" terminal is connected to the power supply.

The connection of external devices to the EXT IN input is shown in the electrical diagram below. Relay outputs or "open collector" signal outputs can be used as the signal source.

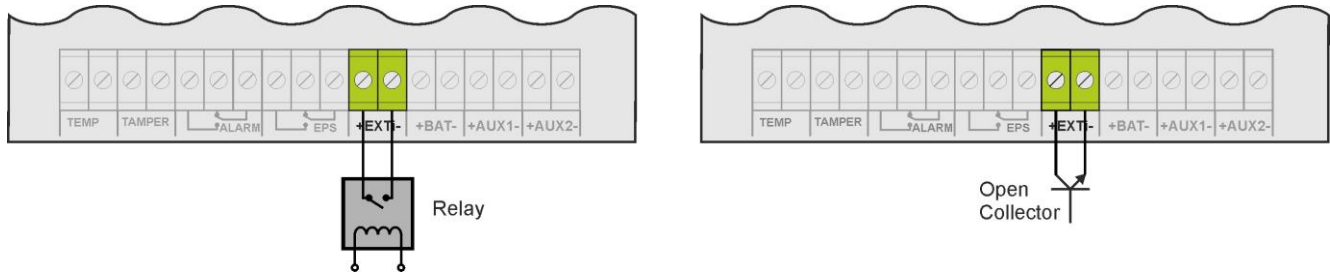

Fig. 10. Connections to the EXTi input.

The EXTi input has been adjusted to work with EN54C-LB4 and EN54C-LB8 fuse modules generating a failure signal in case of a fuse fault in any of output sections (see section 5.7). To guarantee a correct cooperation between the fuse module and the EXTi input, the connections shall be made as presented in the diagram below.

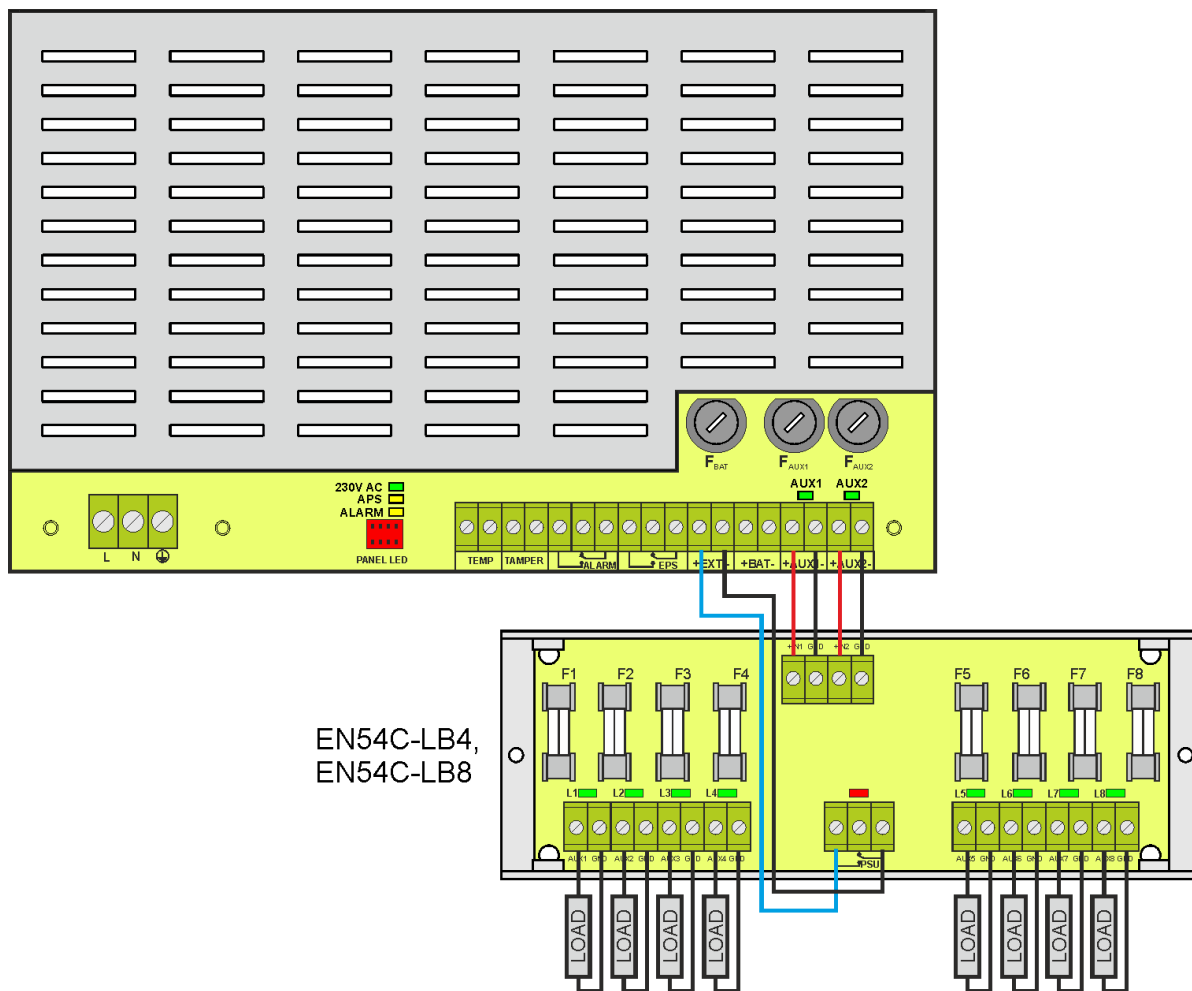

Fig. 11. Example of a connection with the fuse module EN54C-LB8.

5.4. Indication of the enclosure opening - TAMPER.

The PSU is fitted with the microswitch tamper indicating enclosure opening.

The tamper cable is not connected to the terminal in the factory settings. In order to activate tamper, remove the jumper from tamper terminal and plug in the tamper cable. Each opening the enclosure will generate a failure signal at the ALARM technical output.

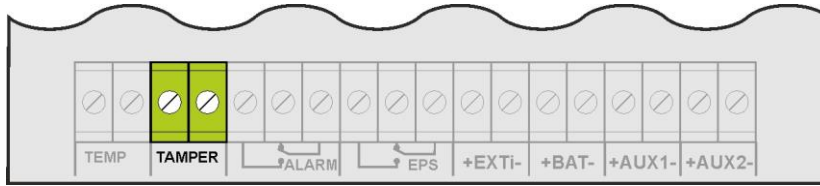

Fig. 12. TAMPER technical output.

5.5. PSU overload.

If the output overload occurs during the PSU operation, the PSU will limit the battery charging current for 1 minute. If, after this time, the overload is removed, the normal charging mode will be restored.

5.6. Short-circuit of the PSU output.

In case of short-circuit of the AUX1 or AUX2 output, one of the fuses - F_{AUX1} or F_{AUX2} – becomes permanently blown. The restoration of the voltage at the output requires the replacement of the fuse.

During a short circuit, the PSU failure is indicated by the ALARM LED and a collective failure signal at the ALARM output.

5.7. Additional modules.

The PSU can be used with optional fuse or sequential modules that will increase its functionality in the case of extended fire protection systems. A place to mount additional modules has been provided inside the power supply housing.



When installing the fuse module in the power supply, take into account the current consumption for the power supply's own needs, which is used for the calculation of the standby time (see section 6.8).

5.7.1. Extending the number of PSU outputs - EN54C-LB4 and EN54C-LB8 fuse modules.

The PSU is fitted with two independently protected outputs for connecting AUX1 and AUX2 receivers. If more receivers are connected to the power supply, it is recommended to secure each of them with an independent fuse. Such a solution will allow avoiding the failure of the entire system in the event of a fault (short circuit on the line) of any of the connected receivers.

The possibility of such protection is provided by the optional EN54C-LB4 (4-channel) or EN54C-LB8 (8-channel) fuse module, for which the mounting location is provided inside the housing (Fig. 3). Figure 10 shows the connection of the power supply, the fuse module, and the receivers (LOAD).

The fuse module, depending on the version, allows connecting 4 or 8 receivers to the power supply.

Output state is indicated by green LEDs.

The blown strip fuse is signaled as follows:

- switching off the appropriate LED: L1 for AUX1 etc.
- the red PSU LED lights up
- switching the PSU relay output into a no-voltage state (contacts as in Figure 11)

In addition, the blown fuse signal is passed to the EXTi input of the collective power supply failure, and the PSU reports a failure at the ALARM output.

The relay output of the PSU fuse strip can be used for remote control, e.g. external optical indication.

5.7.2. Cooperation with electric actuators - EN54C-LS4 and EN54C-LS8 sequential modules.

The sequential modules are designed for use with electric actuators without return spring (EN54C-LS4) and with electric actuators with return spring (EN54C-LS8) used for fire dampers and smoke vents. These devices are used in fire alarm systems and smoke and heat control systems.

When switching on the electric actuator, a short-term current surge, exceeding its rated current, may occur. If multiple electric actuators are connected, the above-mentioned surge current poses a risk of incorrect operation of the power supply (e.g. triggering the protection of output circuit), despite not exceeding the current capacity of the power supply.

The sequential switching module causes the receivers connected to its outputs to be sequentially switched, with a delay of 100 ms. Thanks to this solution, the surge current is reduced to the value ensuring correct operation of the power supply. Thus, it enables safe connection of additional actuators. All outputs are independently protected by PTC polymer fuses and have LED diodes signaling the activation of each output.

The module is controlled by a control device (e.g. a CSP control panel) configuring the resistance at the INPUT connector. The technical output of failure signals failures at the parametric INPUT input.

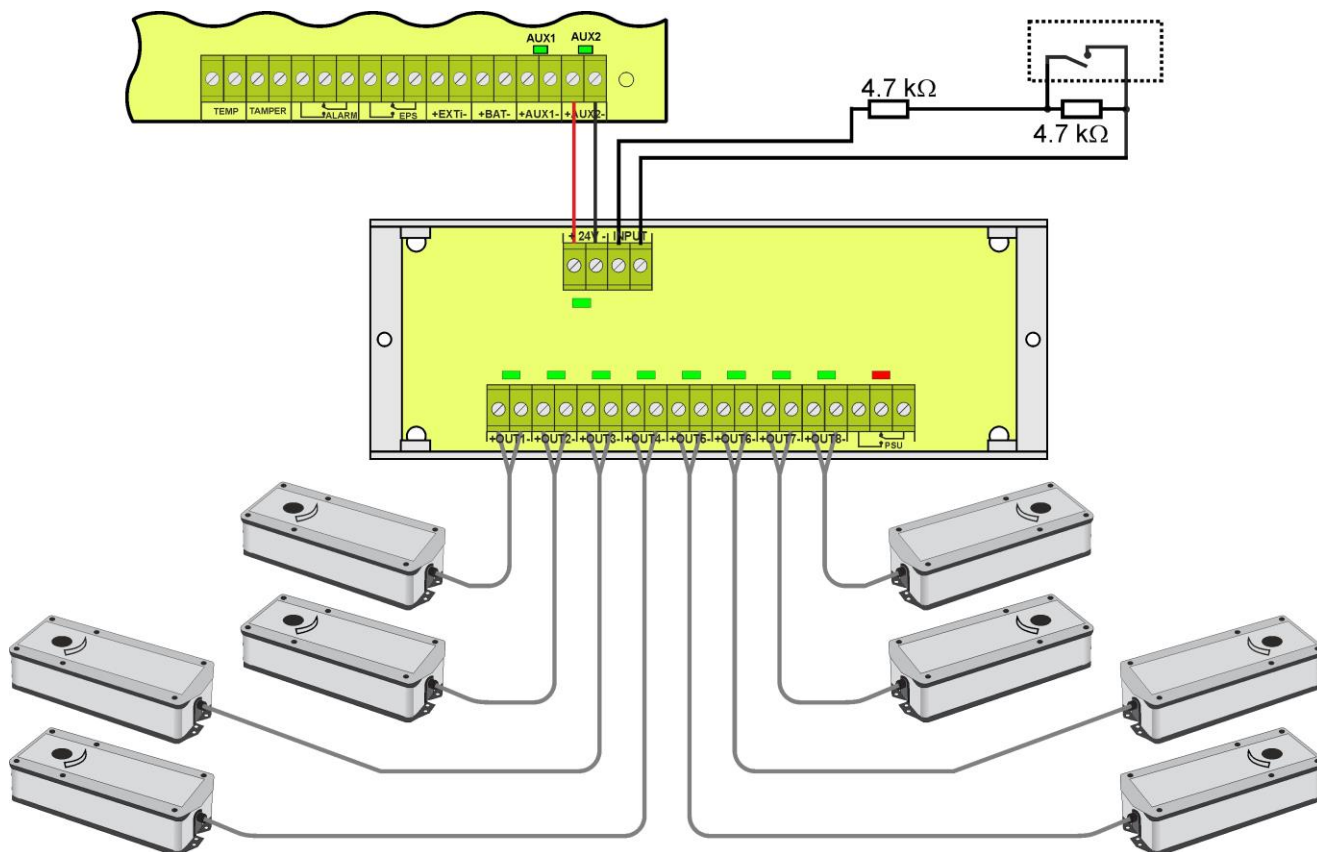

Fig. 13. Example of connection of the EN54C-LS8 sequential module with actuators with return spring.

6. Reserve power supply circuit.

The PSU is fitted with intelligent circuits: battery charging circuit with the function of the accelerated charging and battery control, which main task is to monitor the condition of the batteries and the connections in the circuit.

If the controller detects a power failure in the battery circuit, appropriate indication and change of the ALARM technical output.

6.1. Battery detection.

The control unit of the PSU checks the voltage at the battery terminals and, depending on the measured values, determines the appropriate reaction:

- U_{BAT} below 4 V - batteries not connected to the PSU circuits
- $U_{BAT} = 4$ to 20 V - faulty batteries
- U_{BAT} over 20 V - batteries connected to the PSU circuits

6.2. Protection against short-circuit of the battery terminals.

The PSU is fitted with the circuit protecting against short-circuit of the battery terminals. In case of short circuit, control circuit immediately disconnects the batteries from the rest of the power supply circuit, so the loss of output voltage on power supply outputs is not observed. Automatic reconnection of the batteries to the PSU's circuits is only possible after the removal of the short-circuit and correct connection of the circuits.

6.3. Protection against reverse battery connection.

The PSU is protected against reverse connection of the battery terminals. In case of incorrect connection, the F_{BAT} fuse in the battery circuit becomes blown. The return to normal operation is possible only after replacing the fuse and correct connection of the batteries.

6.4. Deep discharge battery protection UVP.

The PSU is fitted with the disconnection system and the battery discharge indication. If the voltage at the battery terminals drops below $20 V \pm 0.2 V$ during battery-assisted operation, acoustic indication will be activated and the batteries will be disconnected within 15s.

The batteries are reconnected to the power supply unit automatically once the 230 V mains supply is restored.

6.5. Battery test.

The PSU runs battery test every 5 minutes. During testing, the control unit of the PSU measures the electrical parameters according to the implemented measuring method.

A negative result occurs when the:

- battery circuit continuity is interrupted,
- resistance in the battery circuit increases above 300 m Ω
- terminal voltage drops below 24 V.

The battery test will also be automatically locked when the PSU is in the operating mode, in which the battery test is impossible. Such condition occurs, for example, during battery assisted operation.

6.6. Measurement of the resistance of the battery circuit.

The PSU is checking the resistance in the battery circuit. During the measurement, the PSU driver takes into account the key parameters in the circuit, and once the limit value of 300m ohms is exceeded, a failure is indicated.

A failure may indicate considerable wear or loose cables connecting the batteries.

6.7. Battery temperature measurement.

Temperature measurement and compensation of the battery charging voltage can extend the life of the batteries.

The PSU has a temperature sensor to monitor the temperature parameters of installed batteries. It is recommended to place the temperature sensor between the batteries. Be careful not to damage the sensor when moving the batteries.

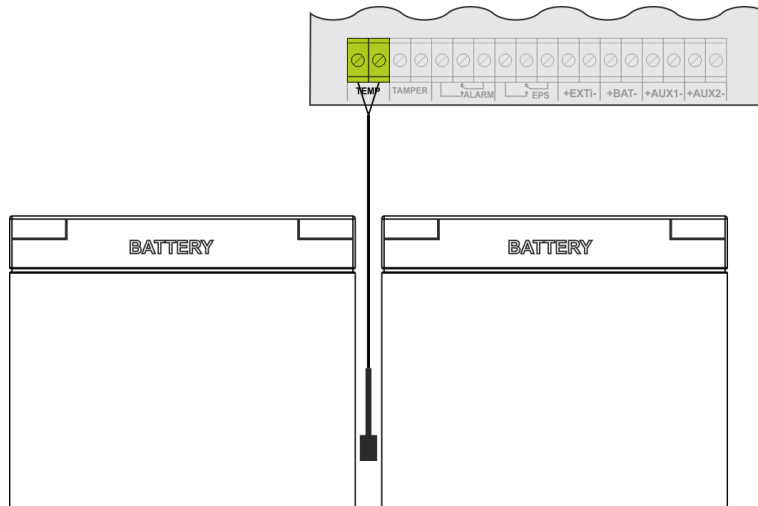

Fig. 14. Mounting of the temperature sensor.



The nominal battery operating temperature recommended by many manufacturers is 25°C. Working at elevated temperatures will significantly shorten the battery lifetime. The service life is reduced by half for each sustained temperature rise of 8°C above the nominal temperature. This means that the battery lifespan, when operated at 33°C, can be decreased by 50%!

6.8. Standby time.

Battery-assisted operating depends on battery capacity, charging level and load current. To maintain an appropriate standby time, current drawn from the PSU in battery mode should be limited.

Required, minimum battery capacity to work with the PSU can be calculated with the following formula:

$$Q_{AKU} = 1.25 \left((I_d + I_z) \cdot T_d + (I_a + I_z) \cdot T_a + 0.05 I_c \right)$$

where:

- Q_{AKU} – The minimum battery capacity [Ah]
- 1.25 – the factor related to the decrease in battery capacity due to aging
- I_d – the current drawn by the load during inspection [A]
- I_z – PSU current consumption (including optional modules) [A] (Table 12)
- T_d – required inspection time [h]
- I_a – the current drawn by the load during an alarm [A]
- T_a – alarm duration [h]
- I_c – short-term output current

7. Technical parameters.

Electrical parameters (Table 4).

Mechanical parameters (Table 5).

Safety of use (Table 6).

Operation parameters (tab.7).

Recommended types and sections of installation cables (Table 8).

Table 4. Electrical parameters.

	EN54C-2A7	EN54C-2A17	EN54C-3A7	EN54C-3A17	EN54C-3A28	EN54C-5A7	EN54C-5A17	EN54C-5A28	EN54C-5A40	EN54C-5A65	EN54C-10A17	EN54C-10A28	EN54C-10A40	EN54C-10A65
Functional class EN 12101-10:2007	A													
Mains supply	230 V													
Current consumption	0,58 A		0,9 A			1,38 A				1,62 A				
Inrush current	40 A		40 A			50 A				60 A				
Power frequency	50 Hz													
PSU's power	56,8 W		85,2 W			142W				284 W				
Efficiency	88%		89%			87%				88%				
Output voltage at 20 °C	22 V± 27,6 V DC – buffer operation 20V± 27,6V DC – battery-assisted operation													
Continuous output current I _{max a}	1,6 A	1,2 A	2,6 A	2,2 A	1,8 A	4,6 A	4,2 A	3,8 A	3,2 A	2,4 A	9,2 A	8,8 A	8,2 A	7,4 A
Instantaneous output current I _{max b} (5 min)	2 A		3 A			5 A				10 A				
Recommended battery capacity	7 Ah	17 Ah	7 Ah	17 Ah	28 Ah	7 Ah	17 Ah	28 Ah	40 Ah	65 Ah	17 Ah	28 Ah	40 Ah	65 Ah
The maximum battery capacity	7,2 Ah	20 Ah	7,2 Ah	20 Ah	28 Ah	7,2 Ah	20 Ah	28 Ah	45 Ah	65 Ah	20 Ah	28 Ah	45 Ah	65 Ah
Battery charging current	0,4 A	0,8 A	0,4 A	0,8 A	1,2 A	0,4 A	0,8 A	1,2 A	1,8 A	2,6 A	0,8 A	1,2 A	1,8 A	2,6 A
Net/gross weight [kg]	3,1/3,3	4,2/4,5	3,1/3,3	4,2/4,5	7,1/7,6	3,1/3,3	4,2/4,5	7,1/7,6	7,1/7,6	12,7/13,4	4,8/5,1	7,7/8,2	7,7/8,2	13,2/13,9
Maximal resistance of the battery circuit	300mΩ													
Ripple voltage (max.)	50mVp-p		50mVp-p			150mVp-p				30mVp-p				
Current consumption by the PSU during battery-assisted operation	52mA		52mA			55mA				85mA				
Coefficient of temperature compensation of the battery voltage	-36mV/ °C (-5 °C-40 °C)													
The LoB low battery voltage indication	U _{bat} < 23 V, during battery mode													
Overvoltage protection OVP	U > 32 V ± 2 V, automatic recovery													

Short-circuit protection SCP	F4 A	F5 A	F6,3 A	F10 A
Overload protection OLP	- F_{AUX1} , F_{AUX2} melting fuse (failure requires fuse replacement) 105-150% of power supply, automatic recovery			
Battery circuit protection SCP and reverse polarity connection	F5 A	F6,3 A	F10 A	F12,5 A
Deep discharge battery protection UVP	- F_{BAT} melting fuse (failure requires fuse replacement) $U < 20$ V ($\pm 2\%$) – disconnection of the batteries			
Tamper indicating enclosure opening	Microswitch TAMPER			
Technical outputs: - EPS FLT; indicating AC power failure	- relay type: 1 A@ 30 V DC /50 V AC - 10s time lag.			
- ALARM; indicating collective failure	- relay type: 1 A@ 30 V DC /50 V AC			
Technical inputs: - EXTi; external failure input	Closed input – no indication Open input - alarm			
- TAMPER; input of the microswitch tamper	Closed input – no indication Open input - alarm			
Optical indication:	- LEDs on the PCB of the power supply unit (see section 3.3) - LED panel <ul style="list-style-type: none"> • ~230 V mains power supply ON • DC power at the AUX outputs • failure indication 			
Fuses: - F_{BAT} - F_{AUX1} - F_{AUX2}	F 5 A/250 V F 4 A/250 V F 4 A/250 V	F 6,3 A/250 V F 5 A/250 V F 5 A/250 V	F 10 A/250 V F 6,3 A/250 V F 6,3 A/250 V	F 12,5 A/250 V F 10 A/250 V F 10 A/250 V
Additional equipment (not included)	- fuse modules: EN54C-LB4, EN54C-LB8 - sequential modules: EN54C-LS4, EN54C-LS8			

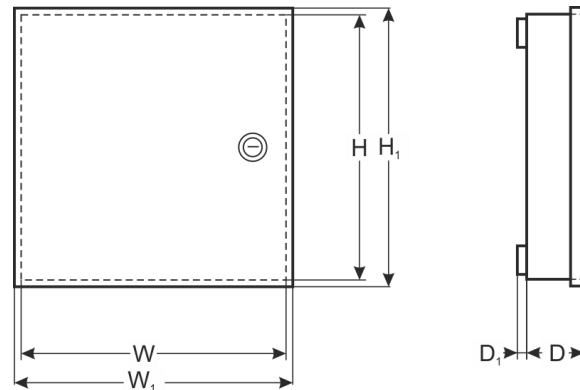
**Table 5. Mechanical parameters.**

Battery space:	2x7 Ah	2x17 Ah	2x28 Ah	2x40 Ah	2x65 Ah
Enclosure dimensions	W=330, H=305, D+D ₁ =82+8 W ₁ =335, H ₁ =308 [+/- 2mm]	W=385, H=402, D+D ₁ =88+8 W ₁ =390, H ₁ =406 [+/- 2mm]	W=420, H=407, D+D ₁ =178+8 W ₁ =425, H ₁ =411 [+/- 2mm]		W=410, H=648, D+D ₁ =180+8 W ₁ =416, H ₁ =652 [+/- 2mm]
Mounting (WxH)	303x230 xΦ6 x4szt [mm]	358x325 xΦ6 x4szt [mm]	388x380 xΦ6 x4szt [mm]		378 x 570 xΦ6 x4szt [mm]
Fitting battery (WxHxD) (max.)	2x7 Ah/12 V (SLA) 315x100x75 [+/-2 mm] max	2x17 Ah/12 V (SLA) 375x180x80 [+/-2 mm] max	2x28 Ah/12 V (SLA) 405x175x170 [+/-2 mm]	2x40 Ah/12 V (SLA) 405x175x170 [+/-2 mm]	2x65 Ah/12 V (SLA) 360x190x170 (x2) [+/-2 mm]
Enclosure	Steel plate DC01 0,7mm		Steel plate DC01 1mm	Steel plate DC01 1,2mm	Steel plate DC01 1,5mm
	color: RAL 3001 (red)				
Closing	Key lock				
Terminals	Battery outputs BAT: 6,3F-0,75	Battery outputs BAT: Φ6 (M6-0-2,5)			
	Mains supply: Φ0,41÷2,59 (AWG 26-10), 0,5÷4mm ² Outputs: Φ0,51÷2,05 (AWG 24-12), 0,5÷2,5mm ²				
Cable glands	PG9 – cable diameter Φ4÷8mm PG11 – cable diameter Φ5÷10mm				
Notes	The enclosure does not adjoin the mounting surface so that cables can be led. Convection cooling.				

Table 6. Safety of use.

Protection class EN 60950-1:2007	I (first)
Protection grade EN 60529: 2003	IP30
Insulation electrical strength: - between input (network) circuit and the output circuits of the PSU - between input circuit and protection circuit - between output circuit and protection circuit	3000 V AC min. 1500 V AC min. 500 V AC min.
Insulation resistance: - between input circuit and output or protection circuit	100 MΩ, 500 V DC

Table 7. Operation parameters.

Environmental class EN 12101-10:2007	1
Operating temperature	-5 °C+40 °C
Storing temperature	-25°C...+60°C
Relative humidity	20%...90%, no condensation
Sinusoidal vibrations during operation: 10 ÷ 50 Hz 50 ÷ 150 Hz	0,1 G 0,5 G
Surges during operation	0,5 J
Direct insolation	unacceptable
Vibrations and surges during transport	According to the PN-83/T-42106 standard

Table 8. Recommended types and sections of installation cables.

Mains supply ~230 V L-N-PE (Table1 [1])	HDGs 3 x 0,75 mm ² ...1,5 mm ² OMY 3 x 0,75 mm ² ...1,5 mm ²
AUX1, AUX2 output terminals (Table 1 [2])	HLGs 2 x 1,5 mm ² ...2,5 mm ²
Indication inputs/outputs (Table 1 [2])	YnTKSY 1 x 2 x 0,8 mm ²

8. Technical inspections and maintenance.

Technical inspections and maintenance can be performed after disconnecting the power supply from the power network. The PSU does not require any specific maintenance, however, its interior should be cleaned with compressed air if it is used in dusty conditions. In case of fuse replacement, use only compatible replacement parts.

Technical inspections should be carried out not less frequently than once per year. During the inspection, check the batteries and run the battery test.

4 weeks after installation, re-tighten all threaded connections, (see Fig 2 [1,2]).



WEEE MARK

According to the EU WEE Directive – It is required not to dispose of electric or electronic waste as unsorted municipal waste and to collect such WEEE separately.



CAUTION! The power supply unit is adapted for cooperation with the sealed lead-acid batteries (SLA). After the operation period they must not be thrown but recycled according to the applicable law.

Pulsar sp.j.

Siedlec 150, 32-744 Łapczyca, Polska
Tel. (+48) 14-610-19-40, Fax. (+48) 14-610-19-50
e-mail: biuro@pulsar.pl, sales@pulsar.pl
http:// www.pulsar.pl, www.zasilacze.pl