



## INSTALLATION GUIDE

ENGLISH

Code: **ARAD4S**

Name: **RACK 4U/270mm universal enclosure  
for RACK 19" two-level cabinets**

Metallic enclosure for RACK cabinet: CCTV, KD, SSWiN, RTV, LAN

**IM ARAD4S**

**IP20**

**RoHS**

Edition: 1 from 20.03.2017  
Supersedes: -----

**EN**

### 1. Intended use:

Due to its design, the ARAD4S enclosure is intended for mounting inside RACK 19" cabinets. This general-purpose enclosure may serve as an auxiliary element for integrating CCTV, AC, I&HAS, RTV, LAN systems in RACK 19" cabinets. It is intended for mounting alarm control panels, AC controllers, power supply units, batteries, etc.

### 2. Description

The enclosure is equipped with two bottom-mounted mounting plates and a removable hinged mounting plate (I and II level) for mounting electronics/transformers/power supply units. The enclosure can accommodate a 17Ah/12V battery and it features tampering protection (against unwanted opening). To enable leading cables into the enclosure, one can buy a cable protection conduit of any length and a cable gland. The conduits and the cable glands are available at the following codes:

- 1) **ARAP16P** – cable gland, inside diameter 16 mm – connection between the protection conduit and the enclosure
- 2) **ARAP21P** – cable gland, inside diameter 21 mm – connection between the protection conduit and the enclosure
- 3) **MM019** – cable protection conduit, inside diameter 16 mm
- 4) **MM020** – cable protection conduit, inside diameter 21 mm

The **ARAD4** enclosure has a space for up to 4x ARAP16P and 8x ARAP21P cable glands.

Optionally, **ARAW45** fans can be mounted. They trigger airflow inside the enclosure after exceeding 45°C. One enclosure can accommodate max. two fan units in the rear part of the enclosure.



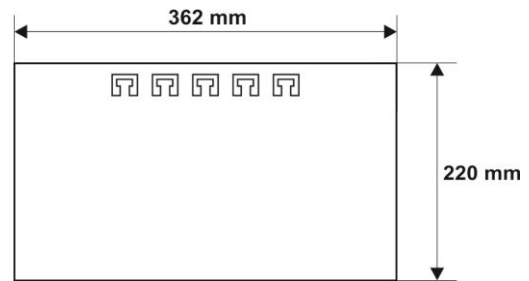
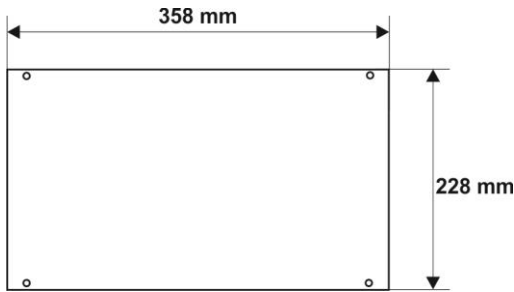
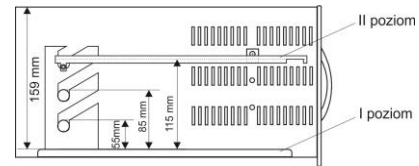
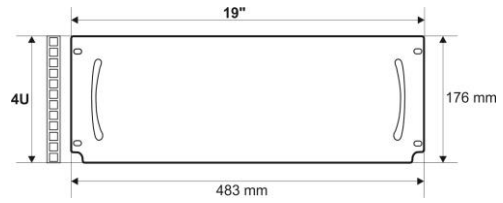
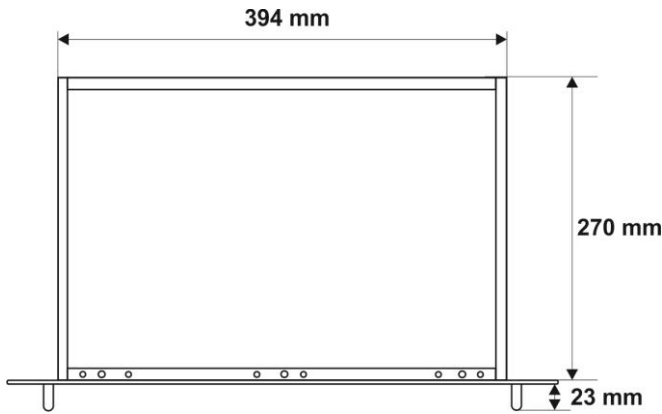

Dimensions of the mounting plate and the hinged plate.

### 3. Assembling instructions:

The ARAD4S enclosure can be mounted in two ways:

1. Mounting without the ARAS450 rails, no extension slide, the front part is the load-bearing part of the enclosure. This method of installation is dedicated for economic versions with a load capacity of up to 5 kg.

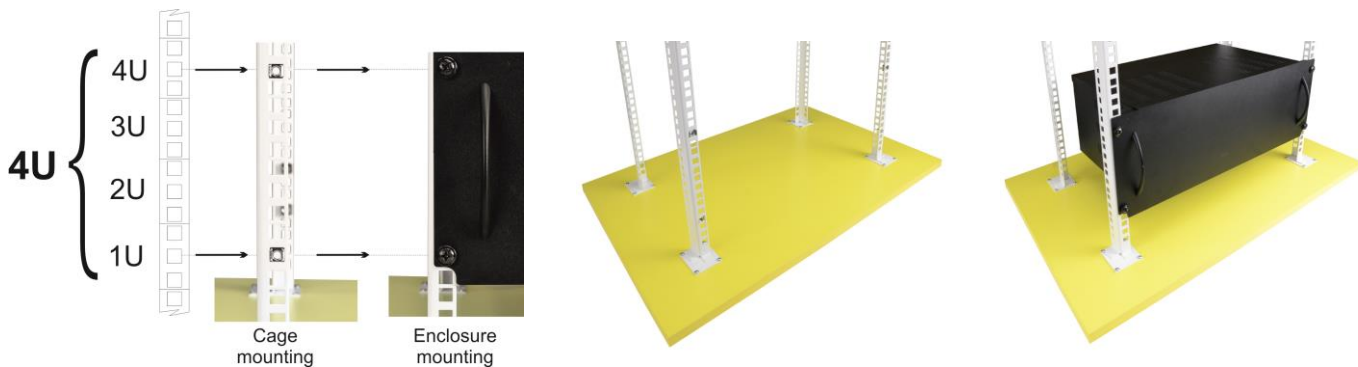

2. Mounting with the ARAS450 rails - full extension slide of the RACK cabinet, rails of the ARAS450 series are the load-bearing part of the enclosure. Dedicated for up to 30kg load.

2.1. Mount cage nuts for M6 screws in the RACK cabinet, as shown in Figure below, and mount the ARAS rails (depending on the depth of the RACK cabinet). Make sure that the rail is correctly mounted horizontally and its length between the front and rear RACK profile is properly adjusted.

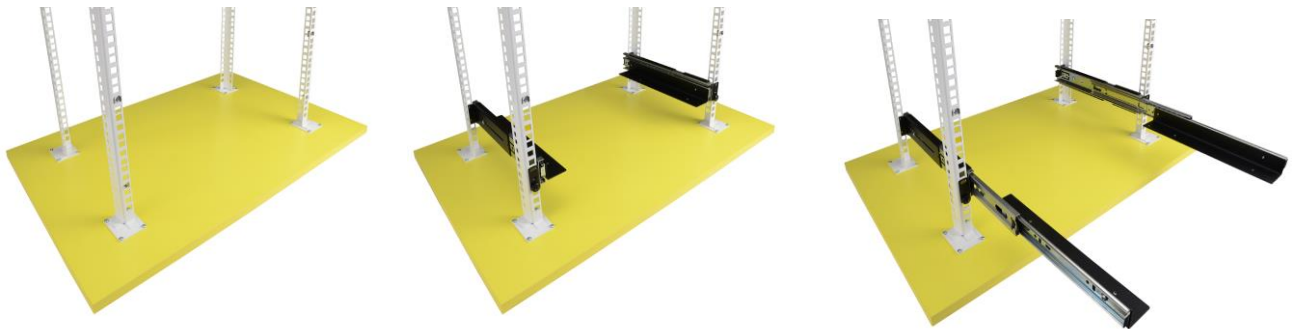
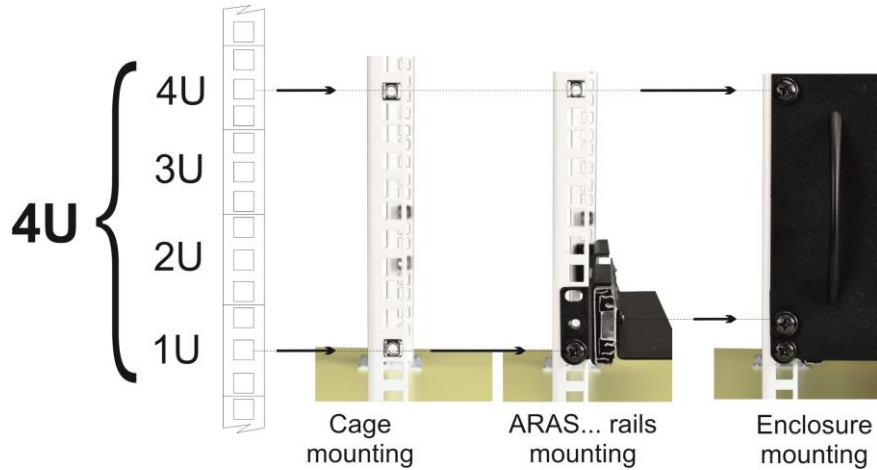

2.2. Mount the ARAD enclosure on fully extended ARAS rails using 4xM4 screws (complete with ARAS rails). Tighten the screws from the inside. The enclosure is mounted in the front of the RACK rails - using 4xM6 screws.



**4. Accessories:**

**Power supplies PS.../PSB.../PSBOC... series  
Transformers of the following series TOR/TRP/TRZ**

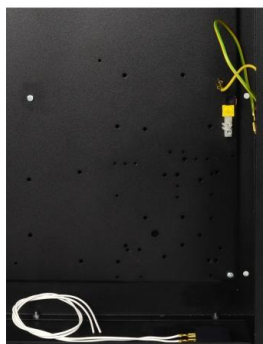

Empty mounting plate



Empty mounting PS., PSB., PSBOC.. series



Enclosed power supply units TOR... series



Transformers TRP... series



Transformers TRZ 20/40 series

## The ARAW45 fan

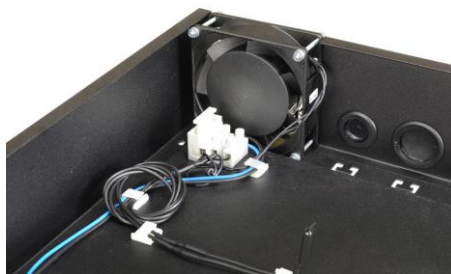
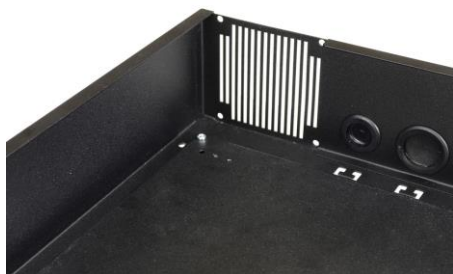

## Cable glands and protection tubes

Wires can be introduced in three ways:

- Through rubber grommets,
- Using the MM019/MM020 protection tubes,
- Using the MM019/MM020 protection tubes and the ARAP16P/ARAP21P cable glands.

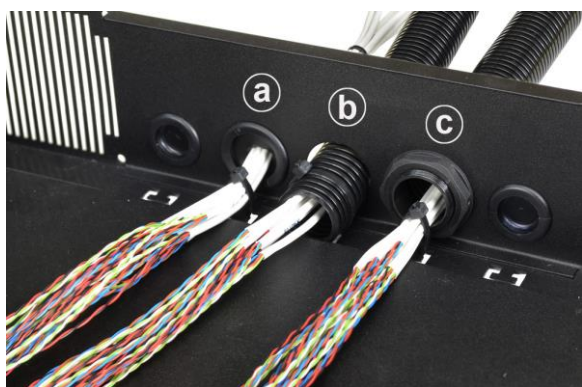

## 5. Specifications

| SPECIFICATIONS                     |  |
|------------------------------------|--|
| Fitting battery                    | <b>17Ah/12V</b>  |
| Tampering protection               | <b>1x – against unwanted opening of the enclosure</b>  |
| Max. load of TAMPER output         | <b>500mA@50VDC</b>   |
| Enclosure: IP                      | <b>IP 20</b>   |
| Operation temperature              | <b>-10°C ÷ 40°C</b>  |
| Relative humidity RH – max.        | <b>90 [%]</b>  |
| Internal dimensions<br>(W x H x D) | <b>390 x 159 x 265<br/>[- / +2] [mm]</b>   |
| Materials                          | <b>Sheet metal DC01, 1,0mm thick + front panel thickness:<br/>1,5mm<br/>Rust protection<br/>Colour: RAL 9005 BLACK</b> |
| Use                                | <b>inside</b>  |
| Net weight                         | <b>~5,82 [kg]</b>  |
| Gross weight                       | <b>~6,42 [kg]</b>  |
| Declarations, warranty             | <b>CE, 2 year from the production date</b>   |

### PRODUCENT / PRODUCER

**Pulsar**  
 Siedlec 150,  
 32-744 Łapczyca, Poland  
 Tel. (+48) 14-610-19-40, Fax. (+48) 14-610-19-50  
 e-mail: [biuro@pulsar.pl](mailto:biuro@pulsar.pl), [sales@pulsar.pl](mailto:sales@pulsar.pl)  
[http:// www.pulsar.pl](http://www.pulsar.pl), [www.zasilacze.pl](http://www.zasilacze.pl)